

TK15 Battery Capacity Tester

—Instruction—

• Sketch :

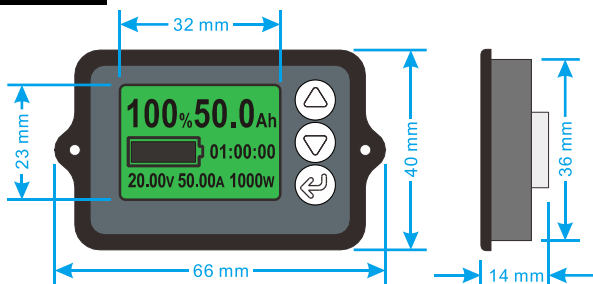

• Product overviews :

★ TK15 is a kind of high precision current type battery capacity tester(also known as coulometer) , which can test the voltage , current and capacity of battery to help users know the state of battery in time. TK15 has memory function. It is suitable for mobile and portable equipment, e-bike, balance car, cleaning machine, instrument, ups and so on.

• Application :

★TK15 is suitable for lithium battery , lithium iron phosphate battery , lead-acid battery and nickel-metal hydride battery which working voltage is from 8V to 100V.

• Basic parameters :

Parameter	Min	Type	Max	Unit
Working voltage	8.0	50.0	100.0	V
Working dissipation		10.0	12.0	mA
Standby dissipation		0.5	0.8	mA
Sleep dissipation		50	60	uA
Voltage accuracy		±1.0		%
Current accuracy		±1.0		%
Capacity accuracy		±1.0		%
Backlight on current(50A)	30		60	mA
Backlight on current(>50A)	80		120	mA
Preset capacity value	0.1		9999.0	Ah
Current of 50A sampler	0.0	50.0	75.0	A
Current of 100A sampler	0.0	100.0	150.0	A
Current of 350A sampler	0.0	350.0	500.0	A
Temperature range	0	20	35	°C
Weight	20			g
Size	66*40*14			mm

Attention : The size and function of TK15 are the same, but the internal parameters are different, so it must match correct sampler, and cannot exchange.

• Working interface description :

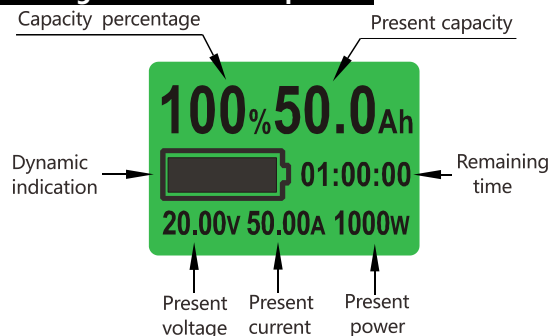

• Connect :

- 1 . First, series connect the sampler to the negative circuit of your battery. B- of sampler connects to B- of battery. P- of sampler connects to P- of output or C- of charge.
- 2 . Then take a wire of 0.3-0.75 mm².One end of the wire connects to positive of battery , another end connects to B+ of sampler (any one is ok).
- 3 . Finally connect sampler to TK15 by the shielded wire. After confirm and power on, TK15 will be work normally.

★ Connection diagram of 50A sampler :

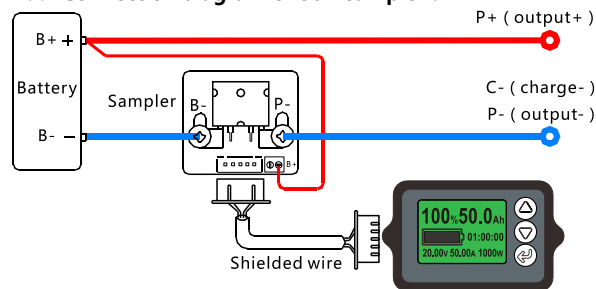

★ Connection diagram of 100A/350A sampler :

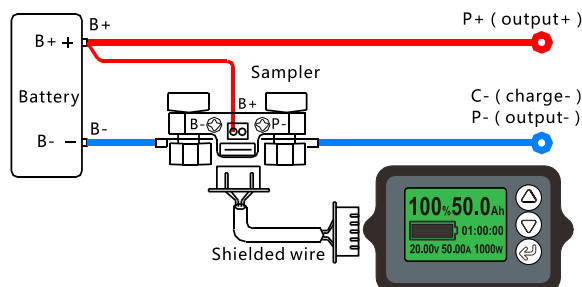

Attention : Please connect as shown strictly. The sampler must be series connected to the negative circuit , it is forbidden to connect to the positive circuit. If you want to extend the shielded wire , you must use 4 lines of same specification.

• Install :

★ First ,open one rectangular orifice and two screw holes on your equipment panel of equipment. Then install TK15 from the front of the panel , and put the shell of TK15 into the rectangular orifice. Finally , fix TK15 with tapping screws from the front of the panel. As shown below:

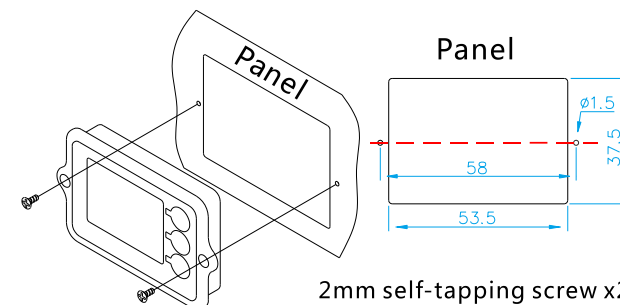

• Using steps :

1. Connect and check the current : Complete the connection as shown and power on , the screen should display the battery voltage , current , capacity percentage and other informations. If the screen has no response , please check the connection. Then charge or discharge the battery, and **check whether the display current is equal to the actual current.** If the deviation is large please check the connection.

2.Capacity reset :On first use ,the percentage and capacity is not the actual value ,you should reset the capacity :discharge the battery totally and **hold the "▽" key for 3s to set the capacity zero** or charge the battery fully and **hold the "△" key for 3s to set the capacity full.** TK15 will be work normally , and it doesn't need to do this again.

3.Check and reset the actual capacity :If you find the display capacity don't match the actual capacity during use , please check and reset the actual capacity : discharge the battery totally and hold the "▽" key for 3s to set the capacity zero ,then set the preset capacity as large as possible. Then charge the battery fully , and the display capacity is the actual capacity. Finally set the display capacity value as preset capacity (Please refer to use setting).

•Other description :

1. When charging or discharging , TK15 must be at work.

Otherwise the capacity will not be accurate.

2. Connect the load , when the discharge current is higher than backlight on current , backlight on (if backlight blinking , means B- and P- of sampler are inversely) indicate batter discharging. Besides , display discharge current and remaining discharge time. The time will fluctuate if the current fluctuate greatly.

3. Break the load , and connect the charger. When the charge current is higher than backlight on current , backlight blinking (if backlight on , means B- and P- of sampler are inversely) indicate battery is charging. Besides , display charge current and remaining time.

4. When the charge or discharge current value is less than backlight off current ,TK15 enter a low power state and backlight off. And TK15 will save the capacity(memory function). Click any one of the keys , backlight on 10s.

5. Because of high sensitivity , when TK15 in standby mode (battery has no input or output current) , if it is interfered by electromagnetic radiation (turn on or turn off inductive loads , such as high-power motor) nearly , the backlight will shortly turn on.



6. When the current changes frequently the date acquisition may produce error , and it will affect the accuracy.

● Use setting :

★ Preset capacity and voltage setting :

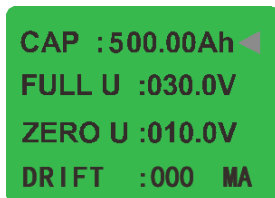
1. Press the “” key for 3s in the main interface to enter setting menu;



2. Press “” or “” key to select items;





CAP—preset capacity : an initial capacity has been set at factory , please set it according to the real capacity of your battery ;

FULL V—full voltage : when the voltage is higher than it the percentage will be 100% ;



ZERO V—zero voltage : When the voltage is lower than it the percentage will be 0% , and backlight off.

DRIFT—Current Zero Calibration: Current Zero Deviation Calibrable Zero;



Attention : Generally the FULL V and ZERO V do not need to set. The default is 0V , means invalid. If you want set , please understand the full charge voltage and all discharge voltage of battery firstly.

3. Select “CAP” and press “” key to enter preset capacity setting. The set bit of capacity value flicker ,press “” key can set other bits , press “” or “” key to plus and minus the value;

4. Press “” key for 3s to finish setting; Other items are the same with this.

5. Press “” and “” key at the same time to exit setting menu.

★ Set capacity zero or full :

On first use or change the battery , the memory capacity should be set zero or full: In the main interface , hold the “” key for 3s to set the capacity zero , the percentage will be 0% ; hold the “” key for 3s to set the capacity full , the percentage will be 100%.

● Attention and warranty :

★ TK15 can't be exposed in the sun for a long time or in the environment with large amounts of ultraviolet radiation when using or storing , particular in winter (< -20°C) and summer (>60°C) , otherwise the LCD will shorten the life span.

★ Within one year , any fault caused by non-artificial reason we will maintain it freely.

Our products will keep upgrading , if the product you bought is different with this instruction , please take the material object or website as the standard.