

# DR42A01 Timer DPDT Relay Module User Manual

The multifunctional relay control module (DR42A01), designed for the customers of different needs, micro-controller as the main control unit, preset 18 kinds of functions, and can be based on user needs, customize and add other specific functions.

The module using of high-quality power relay module, high-power and high-voltage transistor, red signal lights, double-sided PCB board, stable performance, can be widely used in a variety of power control occasions.

Demo video : <https://youtu.be/40SwQ1bIz6w>

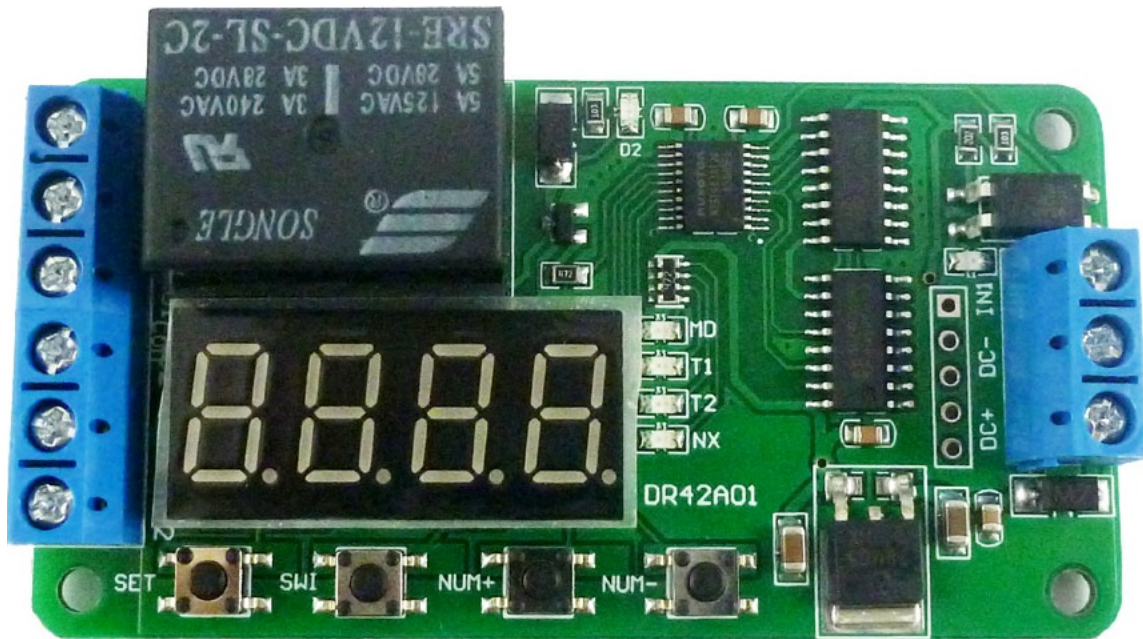

## I. Module Function

The user can select one of the following 18 kinds of function according to keys and display, can set and save the parameters of the 18 kinds of function, also can view the current function parameters, time parameter sets the minimum 0.1 second adjustable, more expertise.

Gentle remind: Function 1-8 start automatically after power on; function 9-18 start required a low level Pulse signal trigger, and the low level duration  $\geq 20\text{ms}$ ; function 9 is self-locking mode; function 10 is a level control mode.

### [Function 1]:

Timing Pull-in: after power on, when arrived the setting time T1, the relay pull-in, and the T1 can be adjustable between 0.1 second -270 hours, give CH1 interface a low pulse signal (low level duration  $\geq 20\text{ms}$ ), repeat the above function.

### [Function 2]:

Timing Disconnect: after power on the relay pull-in, when arrived the setting time T1, the relay disconnect, and the T1 can be adjustable between 0.1 second -270 hours, give IN1 interface a low pulse signal (low level duration  $\geq 20\text{ms}$ ), repeat the above function.

**[Function 3]:**

Timing Pull-in Then Disconnect: after power on, the relay don't pull-in, when arrived the setting time T1 relay pull-in; when arrived the setting time T2 relay disconnect, and the T1 and T2 can be adjustable between 0.1 second -270 hours, give IN1 interface a low pulse signal(low level duration  $\geq 20\text{ms}$ ),repeat the above function.

**[Function 4] :**

Timing Disconnect Then Pull-in : after power on, the relay immediately pull-in, when arrived the setting time T1 relay disconnect; when arrived the setting time T2 relay pull-in, and the T1 and T2 can be adjustable between 0.1 second -270 hours, give IN1 interface a low pulse signal(low level duration  $\geq 20\text{ms}$ ),repeat the above function.

**[Function 5] :**

Unlimited Cycle Timing Mode A: after power on, the relay don't pull-in, when arrived the setting time T1 relay pull-in; when arrived the setting time T2 relay disconnect, then repeat the above status, and the T1 and T2 can be adjustable between 0.1 second -270 hours, give IN1 interface a low pulse signal (low level duration  $\geq 20\text{ms}$ ), repeat the above function.

**[Function 6] :**

Unlimited Cycle Timing Mode B: after power on, the relay immediately pull-in, when arrived the setting time T1 relay disconnect; when arrived the setting time T2 relay pull-in, then repeat the above status, and the T1 and T2 can be adjustable between 0.1 second -270 hours, give IN1 interface a low pulse signal (low level duration  $\geq 20\text{ms}$ ),repeat the above function.

**[Function 7]:**

Limited Cycle Timing Mode A: after power on, the relay don't pull-in, when arrived the setting time T1 relay pull-in; when arrived the setting time T2 relay disconnect, then repeat the above status "NX" times, the T1 and T2 can be adjustable between 0.1 second -9999 seconds, the cycle times "NX" can be adjustable between 1-9999, give IN1 interface a low pulse signal (low level duration  $\geq 20\text{ms}$ ),repeat the above function.

**[Function 8] :**

Limited Cycle Timing Mode B: after power on, the relay immediately pull-in, when arrived the setting time T1 relay disconnect; when arrived the setting time T2 relay pull-in, then repeat the above status "NX" times, the T1 and T2 can be adjustable between 0.1 second -9999 seconds, the cycle times "NX" can be adjustable between 1-9999, give IN1 interface a low pulse signal (low level duration  $\geq 20\text{ms}$ ),repeat the above function.

**[Function 9] :**

Self-locking Mode: give IN1 interface a low pulse signal, the relay pull-in, again give a low pulse signal, the relay disconnect.

**[Function 10] :**

Trigger Mode: contain delay off function, the relay does not operate after power on ,give IN1 interface a low pulse signal, the relay pull-in immediately, when the low pulse signal disappeared, the relay still pull-in, when arrived the setting time T1 relay disconnect, the T1 can be adjustable between 0 second-270 hours. Remark: in this function, if T1 is 0 second, give IN1 connector a low pulse signal, the relay pull-in, when the low pulse signal disappeared, the relay immediately disconnect.

**[Function 11]:**

Trigger timing mode A : the relay does not operate after power on ,give IN1 connector a low pulse signal, when arrived the timing time T1, the relay pull-in ,T1 can be adjustable between 0.1 second -270 hours, give IN1 interface a low pulse signal again, repeat the above function one time.

**[Function 12]:**

Trigger timing mode B: the relay does not operate after power on ,give IN1 interface a low pulse signal, the relay pull-in , when arrived the timing time T1, the relay disconnect,T1 can be adjustable between 0.1 second -270 hours, give IN1 interface a low pulse signal again, repeat the above function one time.

**[Function 13]:**

Trigger timing mode C : the relay does not operate after power on ,give IN1 interface a low pulse signal, when arrived the timing time T1, the relay pull-in ,when arrived the timing time T2, the relay disconnect, timing time T1 and T2 can be adjustable between 0.1 second -270 hours, give IN1 interface a low pulse signal again, repeat the above function one time.

**[Function 14]:**

Trigger timing mode D: the relay does not operate after power on ,give IN1 interface a low pulse signal, the relay pull-in immediately , when arrived the timing time T1, the relay disconnect, when arrived the timing time T2, the relay pull-in, timing time T1 and T2 can be adjustable between 0.1 second -270 hours, give IN1 interface a low pulse signal again, repeat the above function one time.

**[Function 15]:**

Unlimited Cycle Timing Mode A: the relay does not operate after power on ,give IN1 connector a low pulse signal, when arrived the timing time T1, the relay pull-in , when arrived the timing time T2, the relay disconnect, then repeat the above status, T1 and T2 can be adjustable between 0.1 second -270 hours, give IN1 interface a low pulse signal again ,repeat the above function.

**[Function 16]:**

Unlimited Cycle Timing Mode B: the relay does not operate after power on ,give IN1 interface a low pulse signal, the relay pull-in immediately, when arrived the timing time T1, the relay disconnect, when arrived the timing time T2, the relay pull-in, then repeat the above status , T1 and T2 can be adjustable between 0.1 second -270 hours, give IN1 interface a low pulse signal again ,repeat the above function.

**[Function 17]:**

Limited Cycle Timing Mode A: the relay does not operate after power on ,give IN1 interface a low pulse signal, when arrived the timing time T1,the relay pull-in , when arrived the timing time T2,the relay disconnect, then repeat the above status "NX" times, the T1 and T2 can be adjustable between 0.1 second -9999 seconds, the cycle times "NX" can be adjustable between 1-9999,give IN1 interface a low pulse signal again ,repeat the above function.

**[Function 18]:**

Limited Cycle Timing Mode B: the relay does not operate after power on , give IN1 interface a low pulse signal, the relay pull-in immediately, when arrived the timing time T1,the relay disconnect, when arrived the timing time T2,the relay pull-in, then repeat the above status "NX" times, the T1 and T2 can be adjustable between 0.1 second -9999 seconds, the cycle times "NX" can be adjustable between 1-9999,give IN1 interface a low pulse signal again ,repeat the above function.

## II. Operating Instructions

The user can select the operating mode according to keys and display, also can set the timing parameters, all parameters can be automatically saved after setting. Below is some noun descriptions about parameter setting:

**[Keys]:** there are 4 keys, namely: [SET] [SWI], [NUM +] and [NUM-], the keys have short and long press, short press means press the button less than 1 seconds, long press means press the button more than 1 seconds.

**[Operating mode]:** there are 3 kinds, namely: [Operating Mode], [Parameter view mode] and [Parameter setting mode].

**[Digital tube]:** there are 4 digital display, is used to set or view the user timing parameters.

**[LED ]:** 4 red parameter indicators, 1 red power indicator.

**[User parameter]:** there are 4 kinds of parameters can be set (4 LED light to indicate the following parameters)

**[MD]:** MD Light, digital tube displays the current program function, total 18 kinds display mode to choose from (01-18).

**[T1]:** T1 light, digital tube displays timing time T1, can be 0-9999 seconds.

**[T2]:** T2 light, digital tube displays timing time T2, can be 0-9999 seconds.

**[NX]:** NX light, digital tube display the different meanings in different functions.

1. In function 1-6 and 11-16, [NX] light, the digital tube indicates the time base of T1 and T2, the first two digital tube indicate the timing T1, and behind the two digital tube indicate the timing T2, for example: [NX] indicates "01 01" means the timing time unit is 1 second; another example: [NX] indicates "10 02" means the timing time unit of T1 is 10 seconds, T2 is 2 seconds, so the Max timing time is 9999\*99 seconds, which is about 270 hours.

2. In function 7、8、17、18, [NX] light, four digital tube indicates the number of cycles, at this moment, the timing time unit of T1 and T2 is 1 second, so the Max timing time is 9999 seconds in limited cycle timing mode.

## 4 LED Indicate of 4 parameters

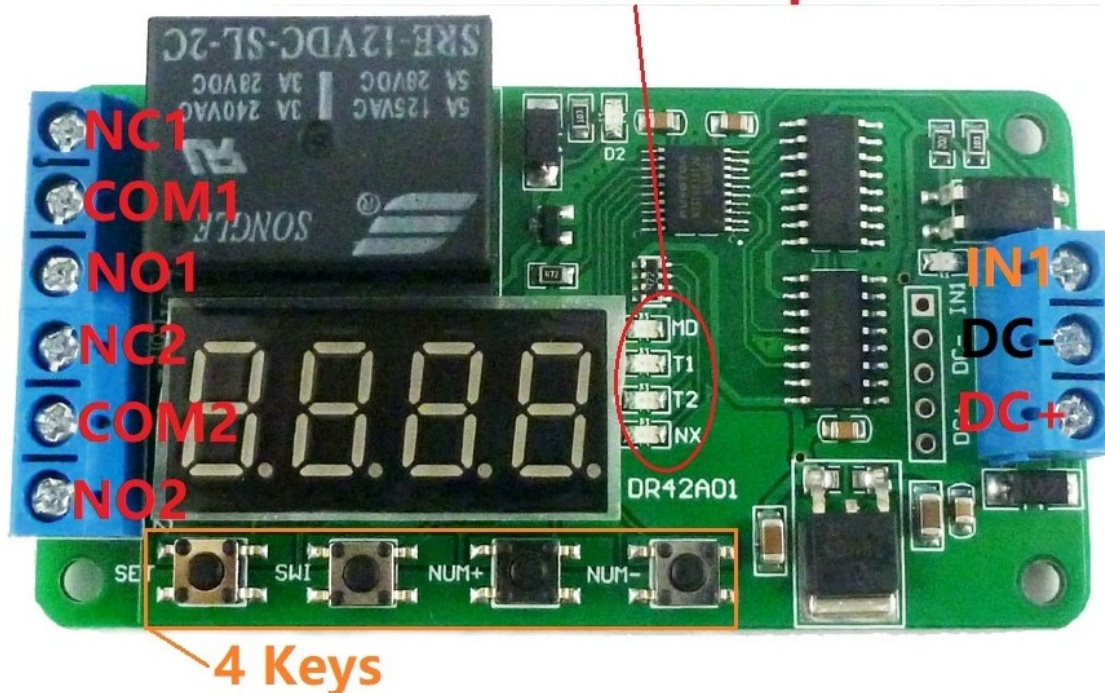

Keys include long press and short press, and in different modes with different functions, the following is to introduce under three mode key's different functions.

### [Operating mode] :

1. When turned on, the digital display current timing countdown, when time to zero, that displays the current function number, such as: " -- 0 1 " means the function1
2. Short press [SET] enter into the power saver, the display goes out, but the program to work normally, press again to restore the display;
3. Long press [SET] enter into [Parameter setting mode];
4. Long press [SWI] enter into [Parameter view mode];
5. Long press [NUM+] into 10 seconds automatic power saving mode, the digital tube will blink twice, which means that the setting is successful. After entering the power saving mode, if no operation of any button within 10 seconds, the digital display will turn off, but the program running, you can short press [SET] to restore the display temporarily, you can also long press [NUM+] again to exit the automatic power saving mode, the digital tube will blink three times to indicate the setting is successful.
6. Long press [NUM-] timing reset and stop, again short press [NUM-] to restore timing, after into reset state, LED lights are no longer flashing.

### [Parameter view mode] :

When turned on, long press [SWI] enter into parameter view mode, under parameter view mode, can view the parameter of the current function, the parameter LED indicator will flash to display.

1. Short press the key [SET], cutover the parameters, can choose one from [MOD]、[T1]、[T2] or [NX], the LED indicator of the selected parameter will flash, the digital tube display the parameters that have been set. Such as: when [T1] light, the digital tube display the content of [ T1].
2. Long press the key [SWI], enter into [Operating mode];

### [Parameter setting mode]:

When turned on, long press [SET] enter into parameter setting mode, under this mode, you can set various parameters, for example, you can select working mode, also can set the delay time etc.

1. Short press the key[SET], cutover the parameters, can choose one from [MOD]、[T1]、 [T2] or [NX], the LED indicator of the selected parameter will long light, the digital tube display the parameters that have been set. Such as: if users need to adjust the working mode, should press the[SET] to make LED indicators point to [MOD] .
2. Short press the key[SWI], cutover the selected digital tube, the relevant digital tube will flash display.
3. Short press the key[NUM+], the selected digital tube numerical +1, add 9 stop;
4. Short press the key[NUM-], the selected digital tube numerical -1, reduced to 0 to stop;
5. Long press the key[SWI], when setting [T1] or [T2] parameter, Long press [SWI] will appear decimal point (Stepping 0.1 seconds), Long press [SWI] again decimal point disappear (Stepping 1 seconds).
6. Long press the key [SET], save the parameters, and enter into [Operating mode].

### For Examp1s:

Example 1. Control a lamp, automatically to run an hour, then turn off.

This application can select the function 2 or function 12, set the parameters: MOD=" - - 12", T1="3 6 0 0", T2="xxxx", NX="0 1 x x "(x can be any value, no need), at the same time, the input interface IN1 as the user switch, below is the set-up process:

- 1> long press[SET] enter into [Parameter setting mode];
- 2> short press[SET], then [MOD] indicator light, press[NUM+] or [NUM-], adjust the digital tube display " - - 12";
- 3> short press[SET], T1 light, set T1="3 6 0 0", T2 no need, X10="0 1 0 1 ";
- 4> long press[SET], save settings, and exit [Parameter setting mode], the function starts running immediately.

Example 2. When power on, the machine is running 1 hour, stop for 10 minutes,

5 cycles, the machine turns off.

This application can select the function 8, set the parameters: MOD=" - - 0 8", T1="3 6 0 0", T2="0 6 0 0", NX="0 0 0 5".



### III. Wiring Reference

#### 1 Control two independent loads (The load is activated simultaneously)

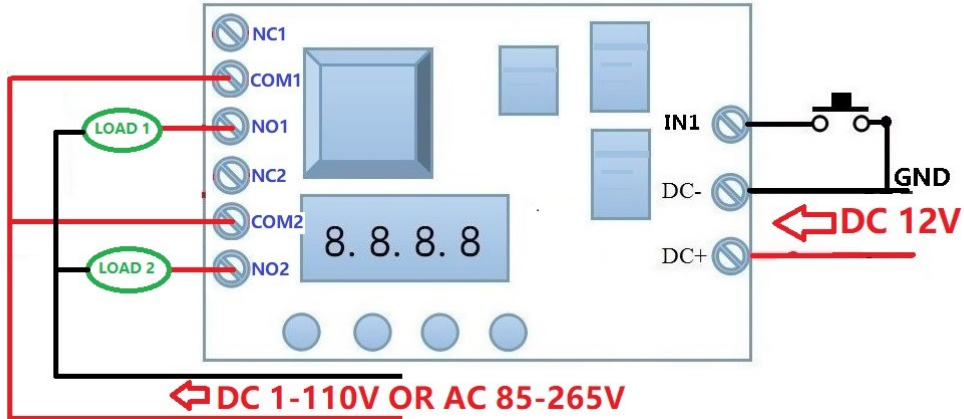

1 Control two independent loads, the load is activated simultaneously

#### 2 Dual channel simultaneously controls one load (load current multiplication)

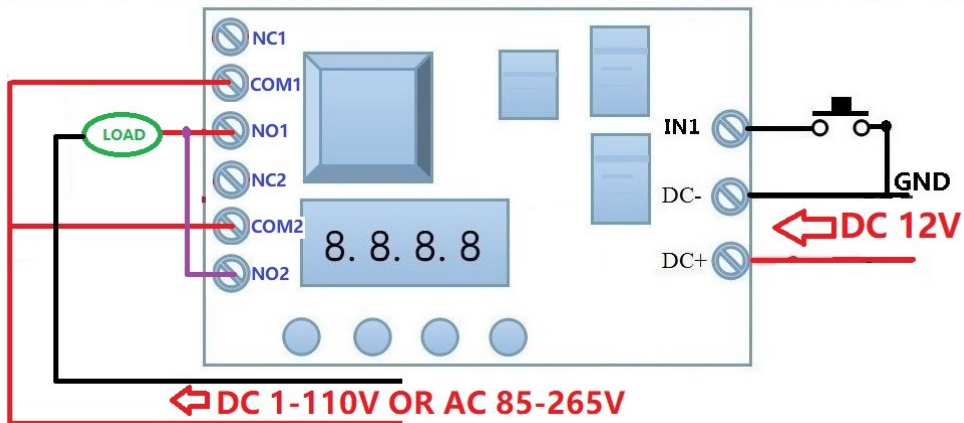

2 Dual channel simultaneously controls one load (load current multiplication)

#### 3 Control the positive and negative wires (off/on the positive and negative wires)

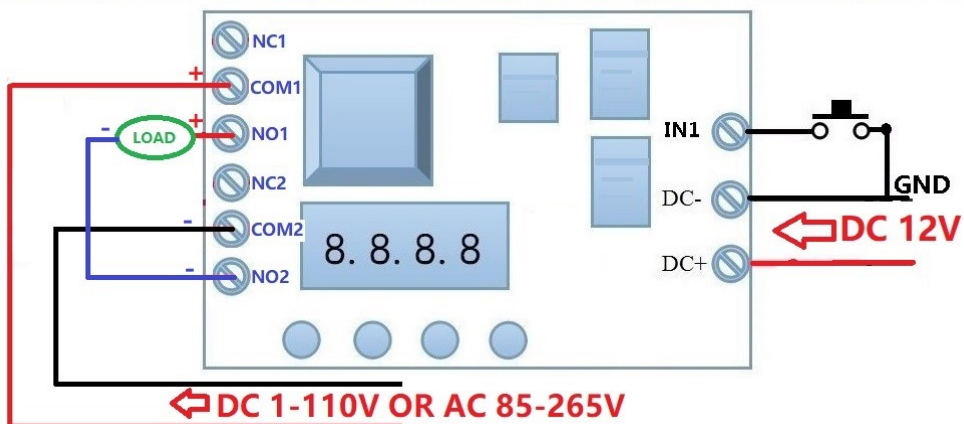

3 Control the positive and negative wires (turn off or turn on the positive and negative wires)

#### 4 Polarity switching output (load can be low power motor)

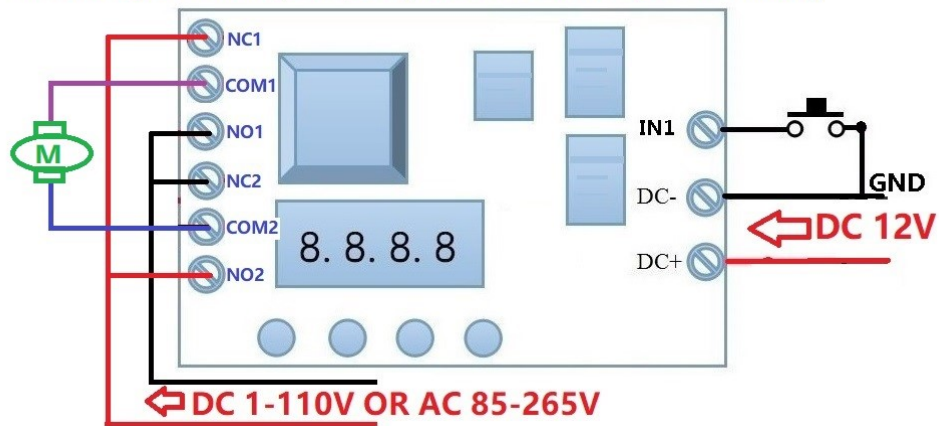

4 Polarity switching output (load can be low power motor)

#### 5 Audio 2 L/R to 1 L/R Switcher

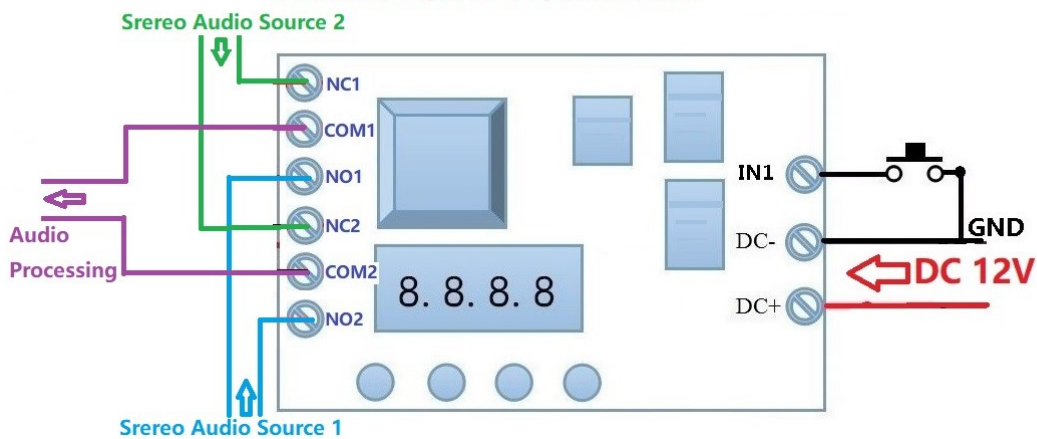

5 Audio 2 L/R to 1 L/R Switcher

### IIII. Electrical parameters

1. Operating Voltage: 12V/(+/-10%)
2. Working Current:  
12V / less than 70mA (when the relay is not operating less than 40mA, turn off the display less than 12mA)
3. Working Temperature: -20°C—60°C (Limit range-30°C—70°C)
4. Load Capacity:  
the module normally open interface maximum load capacity: DC 0-28V/5A, AC 0-125V/5A  
the module normally closed interface maximum load capacity: DC 0-28V/3A, AC 0-240V/3A

#### Restrictions:

1. relay life is loaded with action 100,000 times, and therefore more suitable for use in low frequency and high current pull control of the situation, is not suitable for repeated use in the fast-action situations;.
2. Note consider relay port load margin, purely resistive load more than doubled to left margin, ordinary inductive or capacitive loads must be at least three times more margin.



## IV. Module Interface

**Module Voltage/Signal Input:** There have three interfaces, all interfaces have terminal, user easy to use.

1. **DC+:** DC power positive;

2. **DC-:** DC power negative;

3. **IN1:** Input signal interface. (0-1.5V low voltage to be invalid; 3V-18V high voltage to be valid; 1.5V-3V voltage is unpredictable, you should avoid this voltage range)

**Module Output:** There have three interfaces, all interfaces have terminal.

1. **NO :** Normally open interface, the relay becomes vacant before, after pull-in short with the COM;

- 2. **COM:** Common interface;
- 3. **NC :** Normally closed interface, short with COM before, become vacant after pull-in.

### V. Module Size

- 1. Dimensions: 76mm \* 40mm \* 20mm (L \* W \* H) ;
- 2. Screw Size: 4\* $\phi$ 3.0mm.
- 3. Screw holes center distance: 69mm \* 33mm

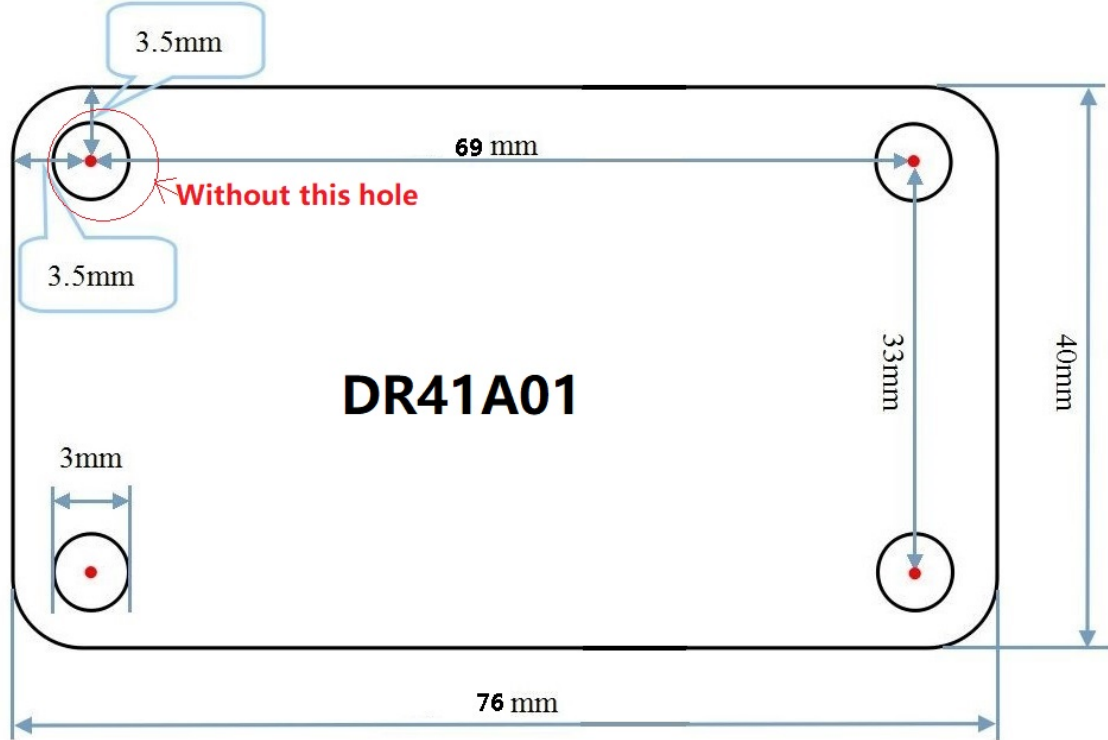

3D View

