

PCB Layout

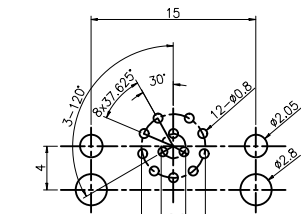

Pin Layout Front view

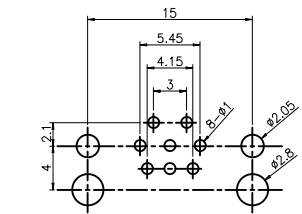
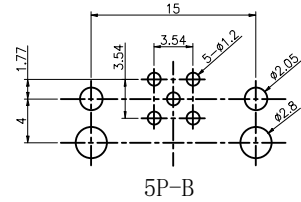
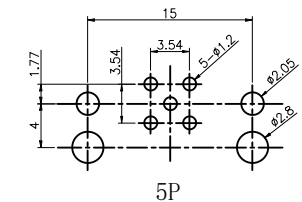
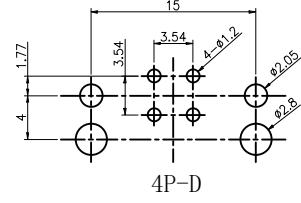
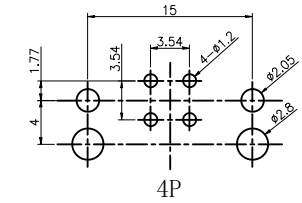
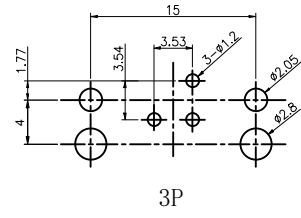
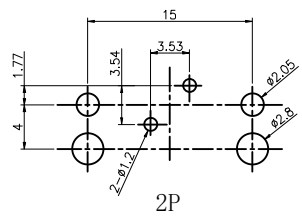
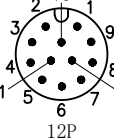
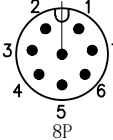
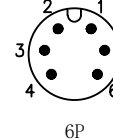
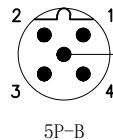
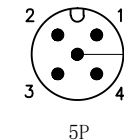
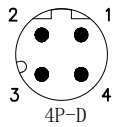
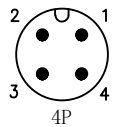
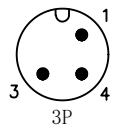
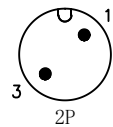

Electrical

Contacts	2	3	4	4D	5	5B	6	8	12
Rated current/ Rated voltage	4A/250V	4A/250V	4A/250V	4A/250V	4A/60V	4A/60V	2A/30V	2A/30V	1.5A/30V
Rated pulse voltage	2500V	2500V	2500V	2500V	1500V	1500V	800V	800V	800V
Insulation resistance (MΩ)	≥100	≥100	≥100	≥100	≥100	≥100	≥100	≥100	≥100
Contact resistance (mΩ)	≤5	≤5	≤5	≤5	≤5	≤5	≤5	≤5	≤5

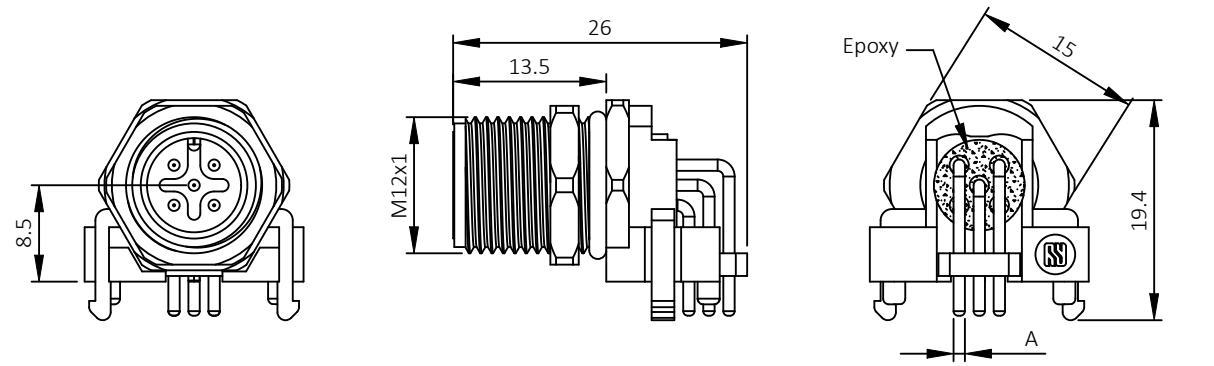

A:
2-5P:Ø1mm
8P:Ø0.8mm
12p:Ø0.6mm

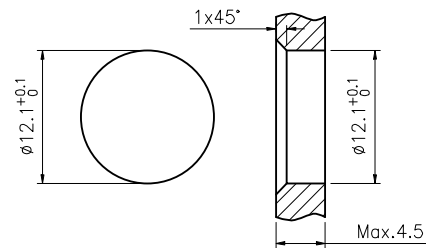

Recommended Panel cut-out

General features:
Comply with IEC61076-2
Mating Cycles: min 500
Temperature Range: -40 to 85° C
Degree of Protection: IP67

Materials:
Contact:CuZn
Contact plating:Gold plated
Contact insert:PA66+GF UL94 black
Shell:CuZn nickel plated
Nut:CuZn nickel plated
Sealing:NBR black

-TOLERANCES-
UNLESS OTHERWISE
SPECIFIED

UNLESS OTHERWISE SPECIFIED
TOLERANCES FOR MILLIMETERS ARE:
0.5 - 8mm ± 0.20mm
8 - 30mm ± 0.25mm
30 - 120mm ± 0.30mm



ELECBEE GROUP

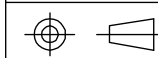

PART DESCRIPTION:
R/A M12 male,Panel Mount,PCB Type

Appr: JIM.KING

P/N: EB-400-8021

Check:

Date	Scale	Unit	Type	Page
2024.01.13	Free	MM	Z	1/1

Draw: DING